

D-01 | OAMARU STONE -SOFFIT DETAIL
- | 1:5

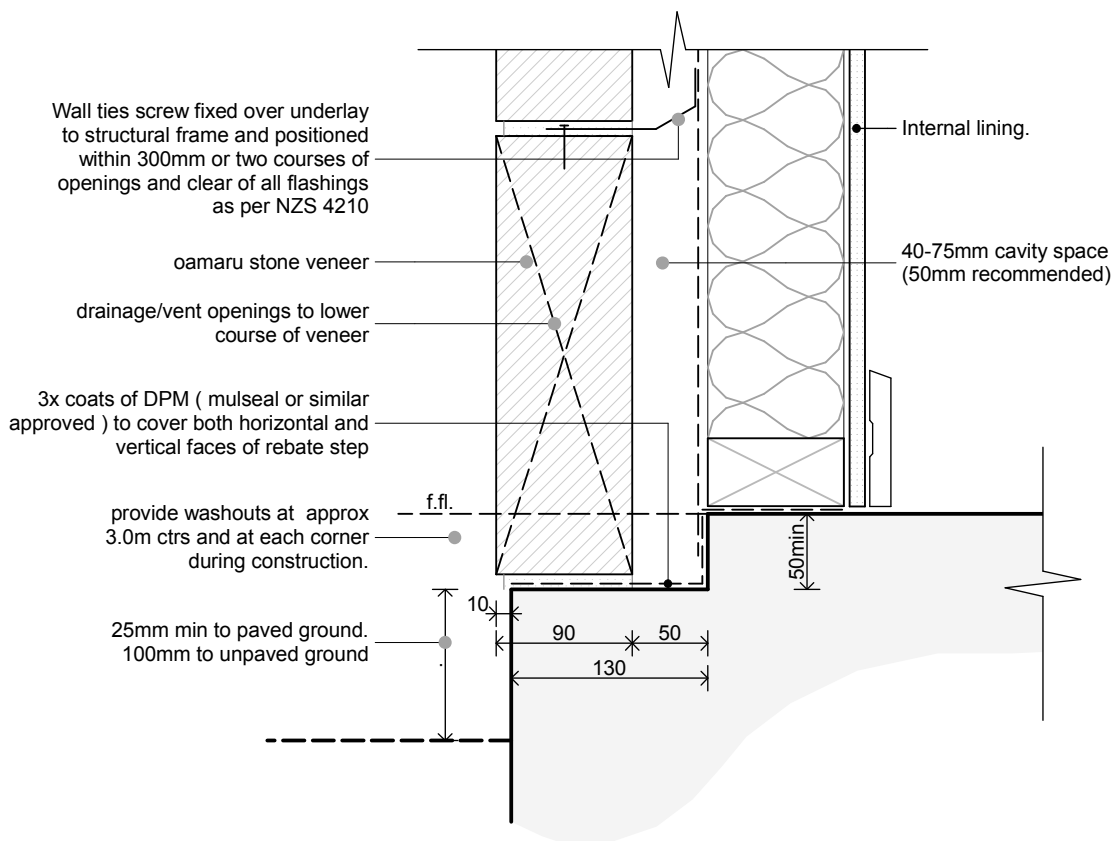

D-02 | OAMARU STONE -BASE DETAIL
- | 1:5

ALL PLANS TO BE READ IN CONJUNCTION WITH PARKSIDE QUARRIES Ltd SPECIFICATIONS



Job Title
OAMARU STONE VENEER CONSTRUCTION DETAILS
For
PARKSIDE QUARRIES Ltd
At
AIREDALE ROAD OAMARU

	Drawn	-----
	Checked	-----
	Creation Date	00/00/0000
	Plot Date	23/09/2015
ALL DIMENSIONS TO BE VERIFIED ON SITE		
ALL DRAWINGS TO BE READ INCONJUNCTION WITH NZBC E2 AS1 9.2		

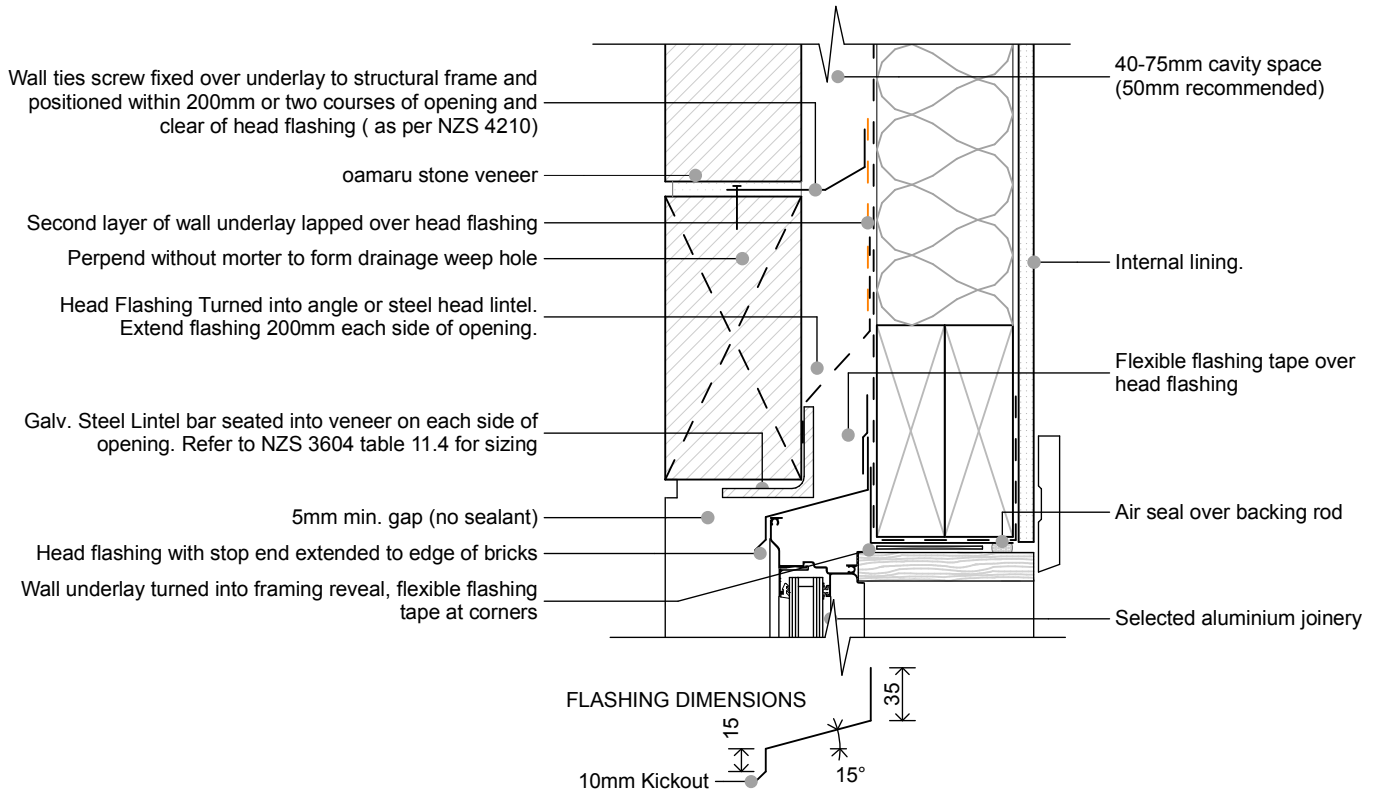

D-03 | OAMARU STONE-HEAD DETAIL
- | 1:5

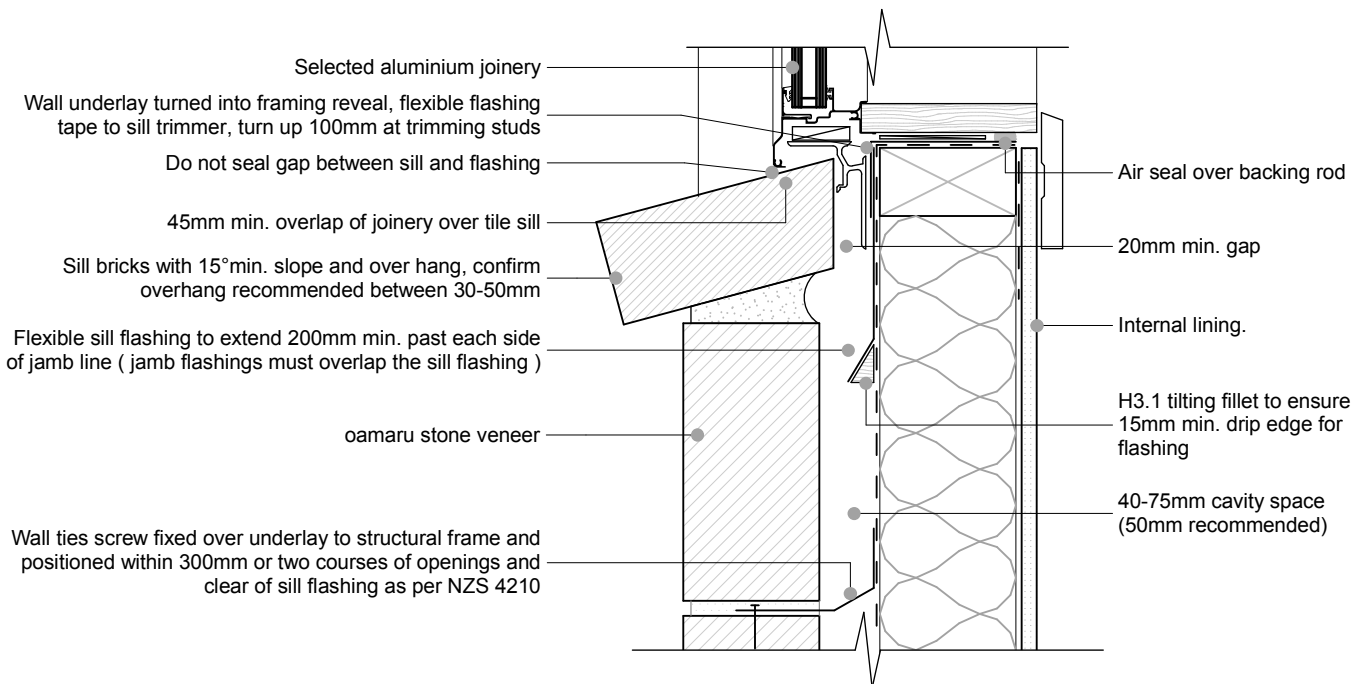

D-04 | OAMARU STONE-SILL DETAIL
- | 1:5

ALL PLANS TO BE READ IN CONJUNCTION WITH PARKSIDE QUARRIES Ltd SPECIFICATIONS

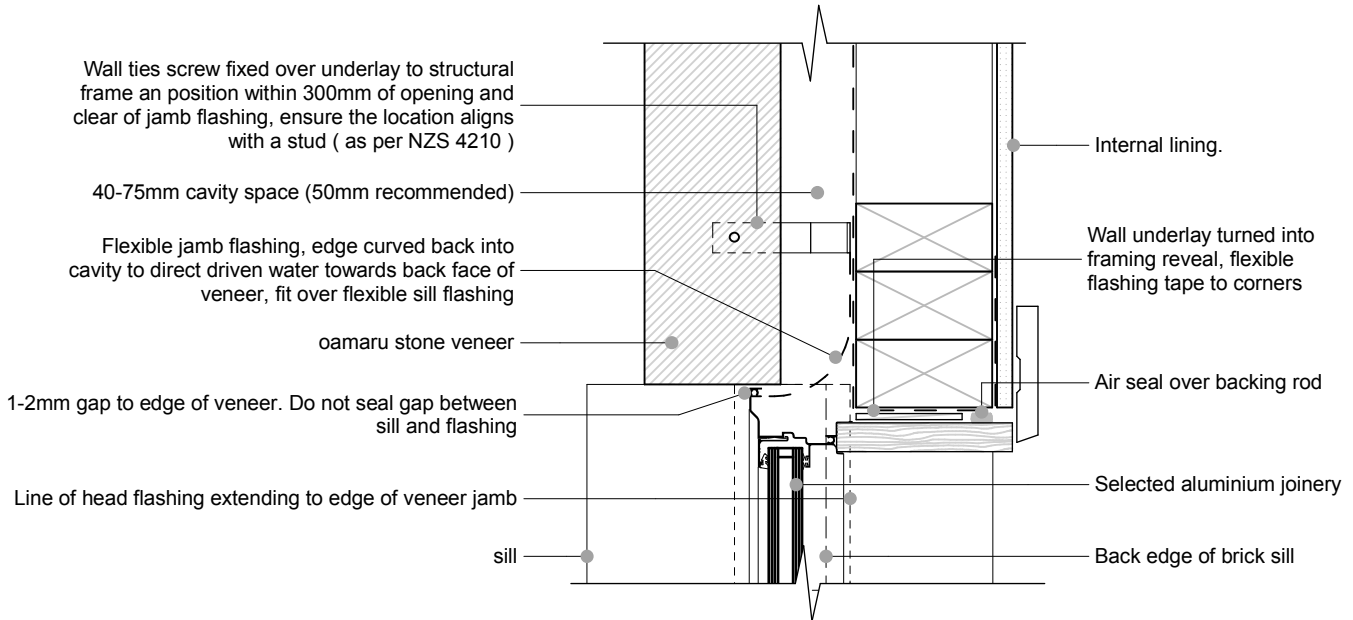

D-05 | OAMARU STONE-JAMB DETAIL
- | 1:5

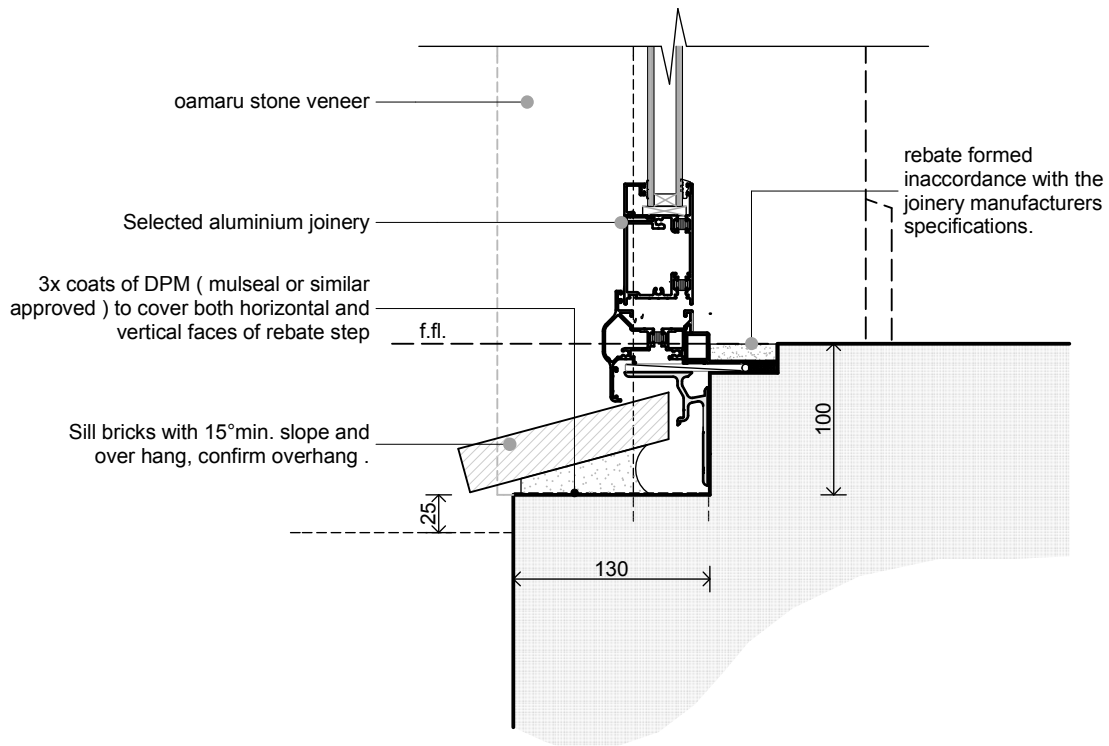

D-06 | OAMARU STONE-DOOR SILL DETAIL
- | 1:5

ALL PLANS TO BE READ IN CONJUNCTION WITH PARKSIDE QUARRIES Ltd SPECIFICATIONS

Job Title

**OAMARU STONE VENEER
CONSTRUCTION DETAILS**

For

PARKSIDE QUARRIES Ltd

At

AIREDALE ROAD OAMARU



Drawn	-----
Checked	-----
Creation Date	00/00/0000
Plot Date	23/09/2015

ALL DIMENSIONS TO BE VERIFIED ON SITE

ALL DRAWINGS TO BE READ INCONJUNCTION WITH NZBC E2 AS1 9.2

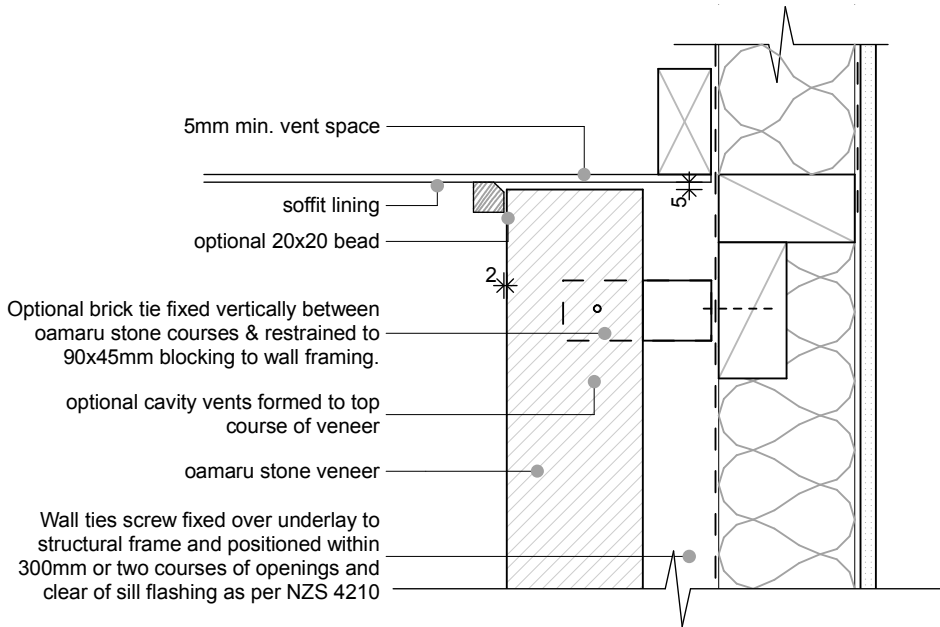

D-07 | OAMARU STONE -ALT. SOFFIT DETAIL
- | 1:5

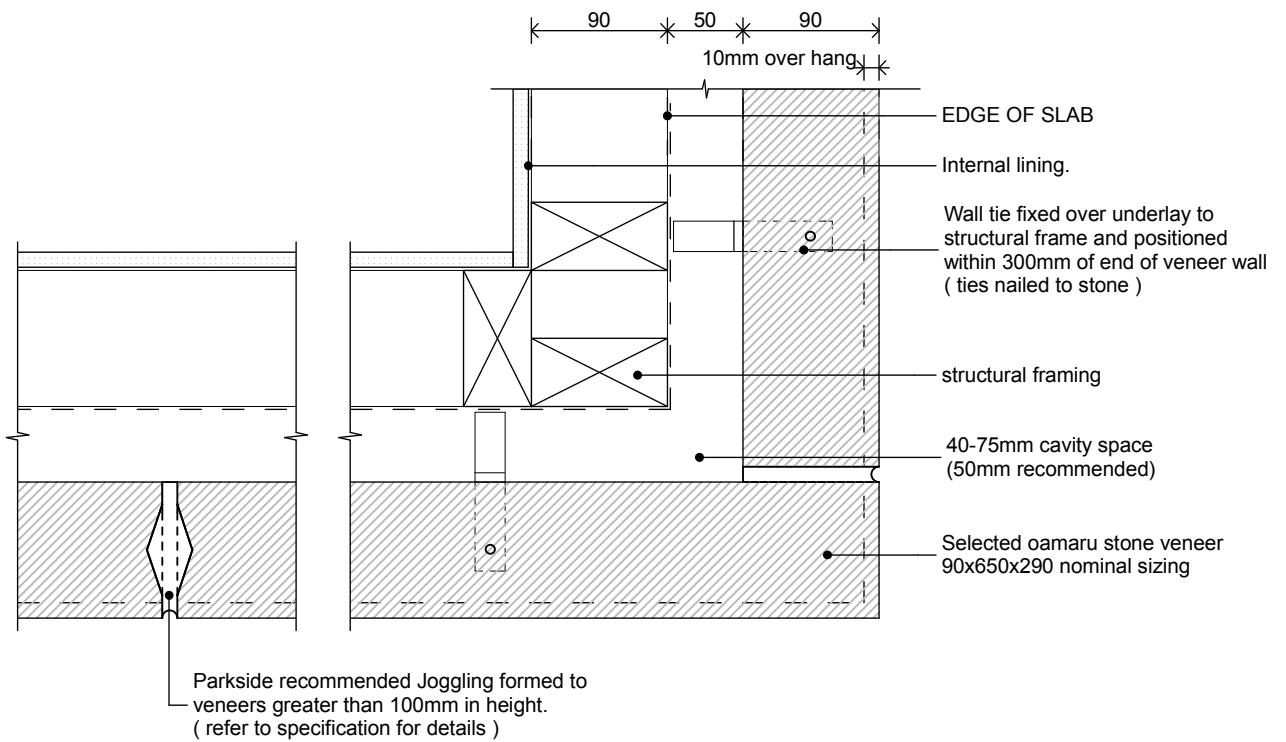

D-08 | OAMARU STONE-CORNER JUNCTION
- | 1:5

ALL PLANS TO BE READ IN CONJUNCTION WITH
PARKSIDE QUARRIES Ltd SPECIFICATIONS



Job Title

**OAMARU STONE VENEER
CONSTRUCTION DETAILS**

For

PARKSIDE QUARRIES Ltd

At

AIREDALE ROAD OAMARU



Drawn	-----
Checked	-----
Creation Date	00/00/0000
Plot Date	23/09/2015

ALL DIMENSIONS TO BE VERIFIED ON SITE

ALL DRAWINGS TO BE READ INCONJUNCTION
WITH NZBC E2 AS1 9.2

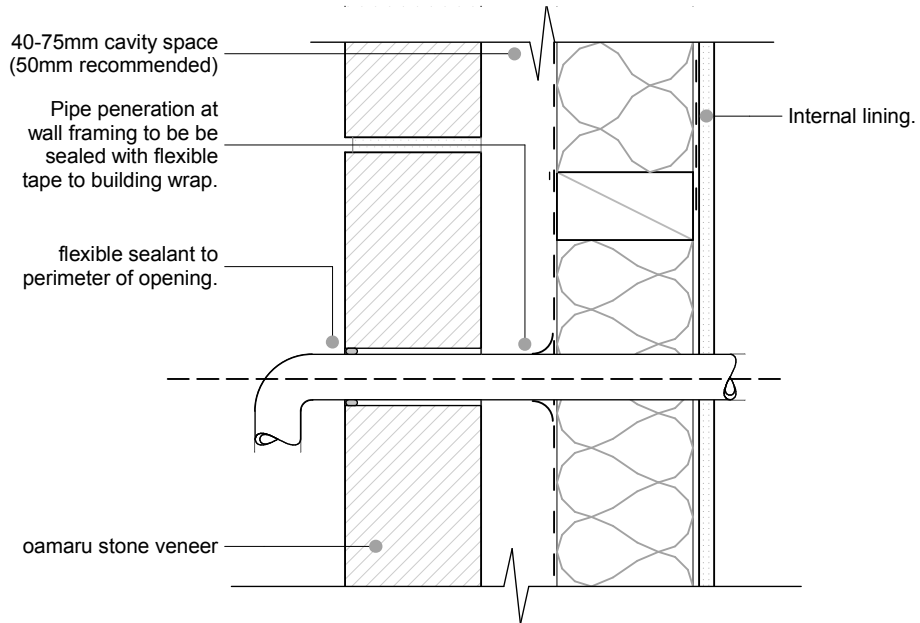

D-09 | OAMARU STONE -PENERATION DETAIL
- | 1:5

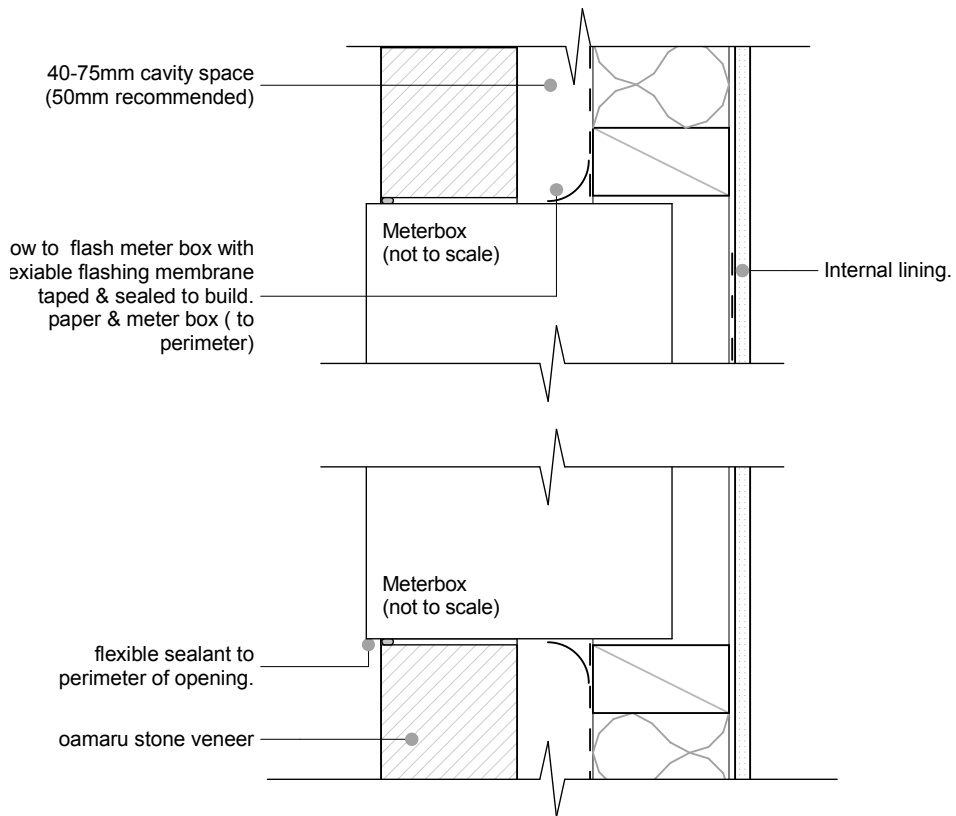

D-10 | OAMARU STONE -METER-BOX DETAIL
- | 1:5

ALL PLANS TO BE READ IN CONJUNCTION WITH PARKSIDE QUARRIES Ltd SPECIFICATIONS